

ACCOUNTANCY
CLASS XII
DESIGN OF THE QUESTION PAPER

Times : 3Hours

Maximum Marks 80

1. Weightage of Objectives

S. NO.	OBJECTIVES	MARKS	% OF MARKS
1.	Knowledge	16	20%
2.	Understanding	56	70%
3.	Application	8	10%
Total		80 Marks	

2. Weightage to form of questions

Form of Questions	Marks for each Question	No. of Questions	Total marks	Time (in minutes) per question
Long Answer	8	1	8	25 minutes
	6	4	24	60 minutes
Short Answer	4	6	24	42 minutes
	3	4	12	20 minutes
Very Short Answer	2	6	12	18 minutes
		21 Questions	80 marks	165+15 minutes for reading and revision

3. Weightage of Content**Part A : Partnership and Accounts (60 marks)**

1.	Accounting for Partnership	5
2.	Reconstitution of Partnership	18
3.	Dissolution of Partnership Firm	10
4.	Accounting of Share Capital	14
5.	Accounting for Debentures	13

Part B : Analysis of Financial Statements (20 marks)

6.1	Analysis of Financial Statements	10
6.2	Statement of Changes in Financial Position	10

OR

Part C : Computerised Accounting (20 Marks)

6.1	Database design for Accounting	8
6.2	Overview of Computerised Accounting System	5
6.3	Application of Computers in Financial Accounting	7

Difficulty Level

Estimated Difficulty Level		Percentage	Marks
A.	Easy	20%	16
B.	Average	60%	48
C.	Difficult	20%	16

Scheme of Options

Internal Choice to be provided in one 8 marks question and two 6 marks questions.

SAMPLE QUESTION PAPER-I

SENIOR SECONDARY SCHOOL EXAMINATION

Subject : Accountancy
Marks : 60
Class XII
Set-1
PART A : PARTNERSHIP AND COMPANY ACCOUNTS

BLUE PRINT

Objectives	Knowledge			Understanding			Application			Total			Total
	LA 6,8	SA 3,4	VSA 2	LA 6,8	SA 3,4	VSA 2	LA 6,8	SA 3,4	VSA 2	LA 6,8	SA 3,4	VSA 2	
1. Accounting for Partnership	-	3(1)	-	-	-	2(1)	-	-	-	-	3(1)	2(1)	5(2)
2. Reconstitution of Partnership firm	-	4(1)	-	8(1)	-	-	6(1)	-	-	14(2)	4(1)	-	18(3)
3. Dissolution of Partnership Firm	-	-	-	6(1)	4(1)	-	-	-	-	6(1)	4(1)	-	10(2)
4. Accounting for Share Capital	-	-	2(1)	6(1)	4(1)	2(1)	-	-	-	6(1)	4(1)	4(2)	14(4)
5. Accounting for Debentures	-	3(1)	-	-	8(2)	2(1)	-	-	-	-	11(3)	2(1)	13(4)
Sub Total (A)	-	10(3)	2(1)	20(3)	16(4)	6(3)	6(1)	-	-	26(4)	26(7)	8(4)	60(15)
Total (A)		12(4)		42(10)			6(1)			60(15)			

Note : Number of Questions are given within brackets and total marks outside the brackets.

SAMPLE QUESTION PAPER-I
SENIOR SECONDARY SCHOOL EXAMINATION

Subject : ACCOUNTANCY**Marks : 20****Class XII****Set-1****PART B : ANALYSIS OF FINANCIAL STATEMENTS****BLUE PRINT**

Objectives	Knowledge			Understanding			Application			Total			Total
	LA	SA	VSA	LA	SA	VSA	LA	SA	VSA	LA	SA	VSA	
Form of Question/Units	6,8	3,4	2	6,8	3,4	2	6,8	3,4	2	6,8	3,4	2	
6.1 Analysis of Financial Statements	-	3(1)	-	-	3(1) 4(1)	-	-	-	-	-	10(3)	-	10(3)
6.2 Statement of changes in Financial Position	-	-	2(1)	6(1)	-	-	-	-	2(1)	6(1)	-	4(2)	10(3)
Sub Total	-	3(1)	2(1)	6(1)	7(2)	-	-	-	2(1)	6(1)	10(3)	4(2)	20(6)
Total (B)	5(2)			13(3)			2(1)			20(6)			
Grand Total (A+B)	17(6)			55(13)			8(2)			80(21)			80(21)

Note : Number of Question are given within brackets and total marks outside the brackets.

SAMPLE QUESTION PAPER-I
SENIOR SECONDARY SCHOOL EXAMINATION

Subject : ACCOUNTANCY (PART C)

Maximum Marks:20

COMPUTERISED ACCOUNTING SYSTEM

Class XII

Set-1

BLUE PRINT

Objectives Form of Question/ Units	Knowledge			Understanding			Application			Total			Total
	LA 6,8	SA 3,4	VSA 2	LA 6,8	SA 3,4	VSA 2	LA 6,8	SA 3,4	VSA 2	LA 6,8	SA 3,4	VSA 2	
6.1 Database Design for Accounting	-	-	2(1)	6(1)	-	-	-	-	-	6(1)	-	2(1)	8(2)
6.2 Overview of Computerised Accounting System	-	3(1)	-	-	-	-	-	-	2(1)	-	3(1)	2(1)	5(2)
6.3 Application of Computers in Financial Accounting	-	-	-	-	4(1) 3(1)	-	-	-	-	-	4(1) 3(1)	-	7(2)
Sub Total (C)	-	3(1)	2(1)	6(1)	7(2)	-	-	-	2(1)	6(1)	10(3)	4(2)	20(6)
Total (C)	5(2)			13(3)			2(1)			20(6)			
TOTAL (A+C)	17(6)			55(13)			8(2)			80(21)			80(21)

SAMPLE QUESTION PAPER-I**ACCOUNTANCY****CLASS XII****Max. Marks : 80****Time Allowed : 3 hrs.****General Instructions**

- (i) This question paper contains three parts A, B and C.
- (ii) Part A is compulsory for all candidates.
- (iii) Candidates can attempt only one part of the remaining Part B and C.
- (iv) All parts of a questions should be attempted at one place.

PART-A**PARTNERSHIP AND COMPANY ACCOUNTS**

1. B and M are Partners in a firm. They withdrew Rs. 48,000 and Rs. 36,000 respectively during the year evenly at the middle of every month. According to the Partnership agreement, interest on drawing is to be charged @ 10% p.a.

Calculate the interest on drawing of the partners using appropriate formula. 2
2. State the provision of Section 78 of Companies Act 1956, regarding the uses of Security Premium Amount. 2
3. How is Share Capital shown in the Company's Balance Sheet as per Section 211 Schedule VI part I of Company's Act 1956? 2
4. Excel Ltd. issued 4,00,000 9% Debentures of Rs. 50 each, payable on application, Pass journal entries at the time of following situations.
 - (i) Issued at par redeemable at 10% Premium 2
 - (ii) Issued at 5% discount, redeemable at 10% premium
5. What is Partnership? List any three main characteristics of Partnership. 3
6. What is meant by debentures? Name any four types of debentures. 3
7. What is meant by revaluation of assets and reassessment of liabilities on the reconstitution of the firm? What purpose does it serve at the time of reconstitution of partnership? 4

8. A, B and C started business on April 1, 2002 with capitals of Rs. 1,00,000, Rs. 80,000 and Rs. 60,000 respectively sharing profits (losses) in the ratio of 4:3:3. For the year ending March 31, 2003, the firm suffered a loss of Rs. 50,000. Each of the partners withdrew Rs. 10,000 during the year.

On March 31, 2003 the firm was dissolved, the creditors of the firm stood at Rs. 24,000 on that date and cash in hand was Rs. 4000. The assets realised Rs. 3,00,000 and Creditors were paid Rs. 23,500 in full settlement of their claim.

Prepare Realisation Account and show your workings clearly. 4

9. Bharat Ltd. was formed on 1.4.2003 with an authorised capital of Rs. 40,00,000 divided into Equity shares of Rs. 10 each.

1. The company issued 5,000 shares to its Promoters as the remuneration of the services rendered by them at par.
2. Company also issued shares at 10% Premium to Mr. Manoj for the Purchase of Assets of Rs. 5,50,000 from him.

Pass the Journal entries for purchase of Assets and Shares issued to Promoters and Mr. Manoj. 4

- 10 Hari Om Ltd. issued 1,50,000 12% debentures of Rs. 100 each at a premium of 10% payable as Rs. 40 on application and balance on allotment. Debentures are redeemable at Par after 3 years. All the money due on allotment was called up and received. Record necessary entries at the time of issue of debentures when premium is included in application money.

11. Mahesh Ltd. issued 1,00,000, 8% Debentures of Rs. 100 each on April 1, 2002 redeemable after 4 years. It has been decided to create Debenture Redemption Reserve for the purpose of redemption of debenture. The Sinking Fund Tables show that Rs. 0.2155 invested in 10% securities will amount to Re. 1 in 4 years. The relevant balances on April 1, 2005 were as follows :

Debenture 8%	=	Rs. 1,00,00,000
Debentures Redemption Fund Investment	=	Rs. 71,33,050
Debenture Redemption Fund	=	Rs. 71,33,050

On March 31, 2006 the investments were sold at book value and the debentures were redeemed.

You are required to pass journal entries for the year ending March 31, 2006. 4

12. X and Y are Partners in a firm sharing Profits in the ratio of 3:2. They decided to admit Z as a new partner w.e.f. April 1, 2003. Future profits will be shared equally. The Balance Sheet of X and Y as at April 1, 2003 and the terms of admission are given below:

Balance Sheet of X and Y

Liabilities	Amount Rs.	Assets	Amount Rs.
Capitals :		Plant and Machinery	4,53,000
X 3,00,000		Furniture and Fittings	62,000
Y <u>3,00,000</u>	6,00,000	Stock	84,000
S. Creditors	60,000	S. Debtors	36,000
Outstanding Expenses	15,000	Cash in hand	40,000
	<u>6,75,000</u>		<u>6,75,000</u>

- (a) Capital of the firm was fixed at Rs. 6,00,000 to be contributed by Partners in the profit sharing ratio. The difference will be adjusted in cash.
- (b) Z to bring his share of capital and Goodwill in cash. Goodwill of the firm is to be valued on the basis of two year's purchase of Super Profit. The average net profit expected in future by the firm is Rs. 90,000 per year. The normal rate of return on capital in similar business is 10%.

Calculate Goodwill and prepare Partners Capital A/c and Bank A/c.

6

13. The Balance Sheet of P, Q and R as on March 31, 2003 who were sharing profits in the ratio of 5:3:1 was as follows :

Liabilities	Amount Rs.	Assets	Amount Rs.
Bills Payable	40,000	Buildings	40,000
Loan From Bank	30,000	Plant and Machinery	40,000
Reserve Fund	9,000	Stock	19,000
Capital P	44,000	S. Debtors	42,000
Q	36,000	Less Prov. for doubtful	<u>2,000</u>
R	20,000	Cash at Bank	40,000
	<u>1,79,000</u>		<u>1,79,000</u>

The Partners dissolved the business. The assets realised - stock - Rs. 23,400, Debtors 50% fixed Assets 10% less than their book value. Bills payables were settled for Rs. 32, 000. There was an outstanding Bill of Rs. 800 which was paid off. Realisation expenses Rs. 1,250 were also paid.

Prepare Realisation Account, Bank Account and Partner's Capital Accounts.

6

OR

Pass necessary Journal entries for the following transactions, at the time of dissolution of the firm :

- (i) Realisation Expenses Rs. 3000 paid.
- (ii) Realisation Expenses paid Rs. 2000, Mr. 'X' one of the partners has to bear these expenses.
- (iii) 'Y', one of the partners, took over a machine for Rs. 20,000.
- (iv) 'Z' one of the partners agreed to take over the creditor of Rs. 30,000 for Rs. 20,000.
- (v) 'A' one of the partners has given loan to the firm of Rs. 10,000. It was paid back to him at the time of dissolution.
- (vi) Profit and Loss Account balance of Rs. 50,000 appeared on the assets side of the Balance Sheet.

14. M. K. Sales Company Ltd. issued a prospectus inviting applications for 1,00,000 shares of Rs. 10 each at a premium of Rs. 2.50 per share payable as follows:

On Application	Rs. 5.00
On Allotment	Rs. 5.00 (including Premium)
On First Call	Rs. 2.50

The Company received applications for 1,50,000 shares, allotment was made on Pro-rata basis. Over subscribed money received on application was adjusted with the amount due on allotment.

Mr. Hemant to whom 200 shares were allotted failed to pay the allotment money and the First Call, his shares were forfeited after the first call. Later on the shares were re-issued to Mohan as fully paid for Rs. 9/- per share.

Pass journal entries in the books of Company, for recording the above transactions.

6

15. The Balance Sheet of A, B and C who were sharing profits in the ratio of 5:3:2, is given below as at March 31, 2003 :

Balance Sheet of A, B and C as at March 31, 2003

Liabilities	Amount (Rs.)	Assets	Amount (Rs.)
Capitals :		Land	4,00,000
A 7,20,000		Buildings	3,80,000
B 4,15,000		Plant and Machinery	4,65,000
C <u>3,45,000</u>	14,80,000	Furniture and Fitting	77,000
Reserve Fund	1,80,000	Stock	1,85,000
Sundry Creditors	1,24,000	Sundry Debtors	1,72,000
Outstanding Expenses	16,000	Cash in hand	1,21,000
	<u>18,00,000</u>		<u>18,00,000</u>

B retires on the above date and the following adjustments are agreed upon his retirement :

- Stock was valued at Rs. 1,72,000.
- Furniture and fittings were under valued by Rs. 3000.
- An amount of Rs. 10,000 due from Mr. D. was doubtful and a provision for the same was required.
- Goodwill of the firm was valued at Rs. 2,00,000 but it was decided not to show goodwill in the books of accounts.
- B was paid Rs. 40,000 immediately on retirement and the balance was transferred to his loan Account.
- A & C were to share future profits in the ratio of 3:2.

Prepare Revaluation Account, Capital Account and Balance Sheet of the reconstituted firm.

8

OR

P, Q and R were Partners sharing profits in the ratio of 3:1:1. The balance sheet of the firm is given below as at March 31, 2002.

Balance Sheet of P, Q and R as at March 31, 2002

Liabilities	Amount (Rs.)	Assets	Amount (Rs.)
Capitals :		Land	2,80,000
P 6,03,000		Buildings	3,40,000
Q 4,12,800		Plant and Machinery	2,48,000
R <u>2,01,900</u>	12,18,000	Furniture and Fitting	48,000
General Reserve	10,000	Stock	1,09,000
S. Creditors	62,000	S. Debtors	1,32,000
		Cash in Bank	1,33,000
	12,90,000		12,90,000

Partnership deed provides for the settlement of claim on death of a partner in addition to his capital as under :

- (i) The share of profit of deceased partner to be computed on the basis of average profits of the past three years for the period from the last balance sheet to date of death of the partner.
- (ii) His share in profit / loss on revaluation of assets and reassessment of liabilities.
- (iii) His share of Goodwill valued on the basis of two years purchase of last three average profits.

Q died on June 1, and the following information is provided :

- (a) Profits for the last three years were :
Rs. 80,000, Rs. 1,30,000 and Rs. 1,50,000
- (b) The assets were revealed as Land Rs. 3,80,000 Plant and Machinery Rs. 1,80,000.
- (c) Q withdrew Rs. 10,000 during the current financial year.
- (d) Rs. 1,00,000 was paid immediately on Q's death to his executors and the balance amount was to be paid later.

Pass the Journal entries to give effect to the transactions relating to death of Q in the books of the firm.

PART B**ANALYSIS OF FINANCIAL STATEMENTS**

16. What are two major inflow and two major outflows of cash from investing activities? 2
17. Mutual Fund Company receives a dividend of Rs. 25 lakhs on its investments in other Company's shares. Why is it a cash inflow from operating activities for this Company? 2
18. What is meant by financial analysis? Mention only two tools used for financial analysis. 3
19. The Current Assets of a company are Rs. 1,26,000 and the current Ratio is 3:2 and the inventories are Rs. 2000. Find out the Liquid Ratio. 3
20. Inventory Turnover Ratio is 3 times. Sales are Rs. 1,80,000, Opening Stock is Rs. 2000 more than the closing stock. Calculate the opening and closing stock when goods are sold at 20% profit on cost. 4
21. The net profit of a company before tax is Rs. 12,50,000 as on March 31, 2003, after considering the following :

Depreciation on Fixed Assets Rs. 25,000

Goodwill written off Rs. 15,000

Loss on sale of Machine Rs. 12,000

The current assets and current liabilities of the company in the beginning and at the end of the year were as follows :

	March 31, 2002	March 31, 2003
Bills Receivables	25,000	15,500
Bills Payables	10,000	12,500
Debtors	30,000	38,800
Stock in hand	18,000	14,000
Outstanding Expenses	8,000	7,000

Calculate Cash flow from operating activities.

6

OR

Q21. Prepare Cash Flow Statement of Rose Ltd. from the following information for the year ended March 31, 2004

Particulars	March 31, 03	March 31, 04
Investments	1,80,000	2,40,000
Fixed Assets (at cost)	2,10,000	4,00,000
Equity Share Capital	10,00,000	14,00,000
Long Term Loan	8,00,000	4,50,000
Cash	64,000	44,000

Additional Information

- i. Cash Flows from operating Activities after tax and extraordinary items Rs. 3,80,000/-
- ii. Depreciation on Fixed Assets Rs. 85,000/-
- iii. Interest received Rs. 45,000/-
- iv. Dividend paid during the year Rs. 1,60,000/-

PART C

COMPUTERISED ACCOUNTING SYSTEM

16. What do you understand by Relation or Relationship type. (2)
17. Explain with one example Multi-group ledgers or Single group ledgers. (2)
18. How do you transform many-to-many relationship into database tables? Illustrate (3)

Accounting Reality for Q. 19, 20 and 21

The following statements describe the accounting reality in any organisation :

- (a) Accounting transactions of an organisation are documented using a voucher.
- (b) Each voucher is assigned a unique number which begins with months of date of voucher followed by a serial number. "05 01" indicates first voucher of May. There are two types of vouchers used for documenting the transaction: Voucher-1 and Voucher-2 as shown below:

Voucher-1

Voucher 05 02		Date : 05-May-2002		
Credit Account : 631001 Cash Account		M/s Satyam Computers		
Debit Account				
S. No.	Code	Name of Account	Amount (Rs.)	Narration
1.	711001	Purchases	60000	Purchases from R. S. Sons
		Total	60000	
Authorised by Aditya			Prepared by Sunil	

Voucher-2

Voucher 04 01		Date : 01-April-2002		
Debit Account : 631001 Cash Account		M/s Satyam Computers		
Debit Account				
S. No.	Code	Name of Account	Amount (Rs.)	Narration
1.	110001	Capital Account	100000	Purchases from R. S. Sons
		Total	100000	
Authorised by Aditya			Prepared by Ramesh	

The transaction Voucher-1 is used for debiting one or more accounts with one accounts with one account being credited. The transaction Voucher-2 is used for crediting one or more accounts with one account being debited.

- (a) Each voucher is prepared by a particular employee and authorised by another employee.
- (b) There is an exhaustive list of Accounts with respect to which the transactions are documented.
- (c) Each Account is classified as belonging to one of the types :
Expenditure, Income, Assets and Liabilities.

Required

19. Conceptualise the above accounting reality in terms of E R Model concepts. (6)
20. Develop and depict an E R Model for this accounting reality. (3)
21. Show the database design in terms of relevant data tables and their inter-relationship. (4)

MARKING SCHEME**SET I**

1. Calculation of Interest on Partners Drawings :

Formula : Drawings x Rate x 6/12 (which amount is drawn in the middle of month)

$$B = \frac{48000 \times 10 \times 6}{100 \times 12} = \text{Rs. } 2400 \quad 1$$

$$M = \frac{36000 \times 10 \times 6}{100 \times 12} = \text{Rs. } 1800 \quad 1$$

2. Provisions of Section 78 of Companies Act 1956 regarding the uses of Security Premium :

- (a) In paying up unissued securities of the company to be issued to members of the company as fully paid bonus securities.
- (b) To write off Preliminary expenses of the Company.
- (c) To write off the expenses of or commission paid or discount allowed on any of the securities of the company.
- (d) To pay premium on the redemption of preference shares or debentures of the company.

$$\frac{1}{2} \times 4 = 2$$

3. Balance Sheet of X Ltd. as per Section 211 Schedule VI Part I

Liabilities	Amount
Share Capital :	
- Authorised Capital	
- Issued Capital	
- Subscribed Capital and called up Capital	
Less calls unpaid	
Add forfeited shares	
(Amount originally paid up)	

4.

Journal entries

(i)	Bank A/C	Dr.	200,00,000	
	Loss on issue of Deb. A/C	Dr.	20,00,000	
	To 9% Debentures A/C			200,00,000
	Premium on realisation of Deb. A/C (Debenture issued at par repayable at premium)			20,00,000
(ii)	Bank A/C	Dr.	190,00,000	
	Loss on issue of Deb. A/C	Dr.	30,00,000	
	To 9% Debenture A/C			2,00,00,000
	To Premium on redemption of Deb. A/C (Debentures issued at discount repayable at Premium)			20,00,000

1 x2 = 2

5. Meaning of Partnership :

The relation between persons who have agreed to share the profit of a business carried on by all or any one of them acting for all.

Characteristics (any three)

1. Two or more persons
2. Agreement between the Partners
3. Business
4. Sharing of Profits
5. Business carried on by all or any one of them acting for all

2+1 = 3

6. Meaning of Debentures :

Debenture is an instrument of debt owed by a Company. As an acknowledgement of debt, such instruments are issued under the seal of a Company and duly signed by authorised signatory.

Types of Debentures (any four)

- (i) Secured;
- (ii) Unsecured;
- (iii) Redeemable;
- (iv) Perpetual;
- (v) Convertible;
- (vi) Non-convertible;
- (vii) Zero coupon rate;
- (viii) Specific rate;

1+2 = 3

7. At the time of reconstitution of a Firm the present value of the Assets maybe different from their book value and the same condition may be with the liabilities. Hence a revaluation of Assets and reassessment of Liabilities becomes necessary to adjust the profit or loss on revaluation in the Capital Accounts of the old Partners in their old profit sharing ratio.

The main purpose of revaluing assets and re-assessing the liabilities is that a partner who gains on account of such a change should compensate the other partner(s) who are expecting loss in their profit share in future.

4

8. Dissolution of a Partnership Firm $\frac{1}{2} \times 4 = 2$

Memorandum Balance Sheet of A, B and C as on 31st March, 2003

Liabilities		Amount (Rs.)	Assets	Amount (Rs.)
A	100,000		Cash in hand	4,000
Less loss	<u>-20,000</u>			
	80,000			
Less Drawings	<u>-10,000</u>	70,000	Sundry Assets	1,80,000
B	80,000		(Balancing Figure)	
Less loss	<u>-15,000</u>			
	65,000			

Less Drawings	10,000	55,000		
C	60,000			
Less loss	<u>-15,000</u>			
	45,000			
Less Drawings	<u>-10,000</u>	35,000		
Creditors		24,000		
		1,84,000		1,84,000

$\frac{1}{2} \times 4 = 2$

($\frac{1}{2}$ mark for correct calculation of each Partners Capital and the amount of assets)

Realisation A/C

To S. Assets	1,80,000	By Creditors	24,000
To Cash A/C	23,500	By Cash	3,00,000
To Capital A/C (Profit)			
A 48,200			
B 36,150			
C 36,150	1,20,500		
	<u>3,24,000</u>		<u>3,24,000</u>

1+1=2

1 mark for placing the figure and 1 mark for calculation and distribution of Profit among Partners

9.

Journal

1.	Formation Expenses A/C	Dr.	50,000	
	To Share Capital A/C			50,000
	(Share issued to promotion)			

2.	Asset A/C To Manoj (Asset purchased from Mr. Manoj)	Dr.	5,50,000	5,50,000
	Manoj To Share Capital A/c To Security Premium A/C (Shares issued to Manoj for purchase of Asset)	Dr.	5,50,000	5,00,000 50,000

1+1+2=4

10.

Date	Particulars	L.F.	Debit	Credit
	Bank A/C To 12% Debenture Application A/C (Debenture application money received)		75,00,000	75,00,000
	12% Debenture Application A/C To 12% Debenture A/c Securities Premium A/C (Application money transferred to 12% Debenture and Securities premium, consequent upon allotment)		75,00,000	60,00,000 15,00,000
	12% Debenture Allotment A/C To 12% Debenture A/C (12% Debenture Allotment made due)	Dr.	90,00,000	90,00,000
	Bank A/C To 12% Debenture Allotment A/C (12% Debenture Allotment money received)		90,00,000	90,00,000

(1 mark for each entry 1x4 = 4 marks)

11.

Journal Entries

31 March, 2006	Bank A/C	Dr.	7,13,305		
	To Interest on Deb. Red. Fund Inv. A/C (Interest received on investments)			7,13,305	1
	Interest on Deb. Red. Fund Investment A/C	Dr.	7,13,305		
	To Deb. Redemption Fund A/C (Interest transferred to Deb. Redemption Fund)			7,13,305	½
	P & L App. A/C	Dr.	21,55,000		
	To Deb. Redemption Fund A/C (Amount of Profit transferred to Deb. Redemption Fund A/C)			21,55,000	1
	Bank A/C	Dr.	71,33,050		
To Deb. Red. Fund Investment A/C (Investments sold at par)			71,33,050	½	
Deb. Red. Fund A/C	Dr.	1,00,01,355			
To General Reserve A/C (The amount of Deb. Red. fund transferred to General Reserve A/C) (7,13,305+21,55,000+71,33,050)			1,00,01,355	½	
8% Debentures A/C	Dr.	1,00,00,000			
To Bank A/C (Debentures redeemed)			1,00,00,000	½	

Total = 4

12. Calculation of Goodwill

Capital	Rs. 6,00,000	given
Normal Rate	10%	given
Expected Profit	90,000	given
Average Profit	60,000	(6,00,000x10/100)
Super Profits	30,000	(90,000-60,000)
Goodwill (30,000x2) = 60,000		

2

Partners Capital A/Cs

	X	Y	Z		X	Y	Z
To X (Goodwill)			16,000	By Balance b/d	3,00,000	3,00,000	
To Y (Goodwill)			4,000	By Bank A/C			2,00,000
To Bank	1,16,000	1,04,000		By Bank A/C			20,000
To Balance c/d	2,00,000	2,00,000	2,00,000	Premium for Goodwill	16,000	4,000	
	3,16,000	3,04,000	2,20,000		3,16,000	3,04,000	2,20,000

3

Bank A/C

To Balance b/d	40,000	By X's Capital	1,16,000
To Z's Capital	2,00,000	By Y's Capital	1,04,000
To Z's Capital (brought in by Z)	20,000	By Balance b/d	40,000
	2,60,000		2,60,000

1

Working Notes :**Sacrificing Ratio :**

$$X \quad \frac{3}{5} \quad - \quad \frac{1}{3} \quad = \quad \frac{9 - 5}{15} \quad = \quad \frac{4}{15}$$

$$Y \quad \frac{2}{5} \quad - \quad \frac{1}{3} \quad = \quad \frac{6 - 5}{15} \quad = \quad \frac{1}{15}$$

$$2+3+1 = 6$$

Realisation A/C

	Rs.		Rs.
To Building	40,000	By Bills Payable	40,000
To Plant and Machinery	40,000	By Loan from Bank	30,000
To Stock	19,000	By Reserve for Bad Debts	2,000
To Debtors	42,000	By Bank (Stock)	23,400
To Bank (Bills Payable)	32,000	By Bank (Debtors)	21,000
To Bank (Bank Loan)	30,000	By Bank (Fixed Assets)	72,000
To Bank (Realisation Exp)	1,250	By Partners Capital A/C	
To Bank (Repair Bill)	800	P 9,250	
		Q 5,550	
		R 1,850	16,650
	2,05,050		2,05,050

2½

Bank A/c

To Balance b/d	40,000	By Realisation (BP)	32,000
To Realisation (Stock)	23,400	By Bank Loan	30,000
To Realisation (Debtors)	21,000	By Realisation Expenses	1,250
To Realisation (Fixed Assets)	72,000	By Repairs Bill	800
		By Capital P 39,750	
		Q 33,450	
		R 19,150	92,350
	1,56,400		1,56,400

2½

Partners Capital A/c

Dr.

Cr.

Particulars	P	Q	R	Particulars	P	Q	R
To Realisation (Loss)	9,250	5,550	1,850	By Balance B/d	44,000	36,000	20,000
To Bank A/c	39,750	33,450	19,150	By Reserve Fund	5,000	3,000	1,000
	49,000	39,000	21,000		49,000	39,000	21,000

1½

OR

Journal Entries

(i)	Realisation A/c	Dr.	3,000	
	To Bank A/c			3,000
	(Realisation expenses paid)			
(ii)	X's Capital A/c	Dr.	2,000	
	To Bank A/c			2,000
	(X bears Realisation Expenses)			
(iii)	Y's Capital A/c	Dr.	20,000	
	To Realisation A/c			20,000
	(Y took over machine)			
(iv)	Realisation A/c	Dr.	20,000	
	To Z's Capital A/c			20,000
	(Z's took over the credit)			

(v)	A's Loan A/c To Bank A/c (A's loan paid)	Dr.	10,000	10,000
(vi)	All the Partners Capital A/c To P & L A/c (Loss charged to Partners Capital A/c)	Dr.	50,000	50,000

1 x 6 = 6

14. Journal Entries

M.K. Sales Company

Date	Particulars	LF	Amount Dr. (Rs.)	Amount Cr. (Rs.)
	Bank A/c To Share Application A/c (Received application money for 150,000 shares @ Rs. 5)	Dr.	7,50,000	7,50,000
	Share application A/c To Share Capital A/c To Share allotment A/c (Application money adjusted)	Dr.	7,50,000	5,00,000 2,50,000
	Share allotment A/c To Share Capital A/c To Security Premium A/c (Allotment money due)	Dr.	5,00,000	2,50,000 2,50,000

	Bank A/c	Dr.		2,49,500	
	Calls in Arrears A/c	Dr.		500	
	To Share Allotment A/c				2,50,000
	(Allotment money received for 99800)				
	Share first call A/c	Dr.		2,50,000	
	To Share Capital A/c				2,50,000
	(First call Money Due)				
	Bank A/c	Dr.		2,49,500	
	Call in Arrears A/c	Dr.		500	
	To Share First Call A/c				2,50,000
	(First call money received for 99,800 shares)				
	Share Capital A/c	Dr.		2,000	
	Security Premium A/c	Dr.		500	
	To Call in Arrears A/c				1,000
	To Share forfeited A/c				1,500
	(200 shares forfeited)				
	Bank A/c	Dr.		1,800	
	Share Forfeited A/c	Dr.		200	
	To Share Capital A/c				2,000
	(200 shares reissued)				
	Share forfeited A/c	Dr.		1,300	
	To Capital Reserve A/c				1,300
	(Excess amount in Share forfeited A/c transferred to Capital Reserve A/c)				

½ Mark to each correct entries 1 to 6 = ½x6 = 3

½ Mark to each correct entry from 7 to 9 = 1x3 = 3

15.

Revaluation A/c

To Stock	13,000	Furniture & Fittings	3,000
Provision for Bad & Doubtful debts	10,000	Loss A 10,000	
		B 6,000	
		C 4,000	20,000
	23,000		23,000

2

Partners Capital A/cs

	A	B	C		A	B	C
To Revaluation (Loss)	10,000	6,000	4,000	By Balance b/d	7,20,000	4,15,000	3,45,000
To B's Capital A/c (goodwill)	20,000		40,000	By Reserve Fund	90,000	54,000	36,000
To Cash A/c (Goodwill)		40,000		By A's Capital A/c		20,000	
To B's Loan A/c		4,83,000		By C's Capital A/c		40,000	
To Balance b/d	7,80,000		3,37,000				
	8,10,000	5,29,000	3,81,000		8,10,000	5,29,000	3,81,000

1+1+1=3

Balance Sheet of A and C as on 31st March,2003

Capital A	7,80,000	Land	4,00,000
C	3,37,000	Building	3,80,000
B's Loan A/c	4,83,000	Plant & Machinery	4,65,000
S.Creditors	1,24,000	Furniture & Fittings	80,000
Outstanding Expenses	16,000	Stock	1,72,000
		Debtors 1,72,000	
		Less Pro. of B D <u>10,000</u>	1,62,000
		Cash in Hand	81,000
	17,40,000		17,40,000

3

Working Notes:

$$\begin{array}{l} \text{Gaining ratio:} \\ \text{A} \quad \frac{3}{5} - \frac{5}{10} = \frac{6-5}{10} - \frac{1}{10} \quad \text{Gain} \\ \\ \text{C} \quad \frac{2}{5} - \frac{2}{10} = \frac{4-2}{10} - \frac{2}{10} \quad \text{Gain} \end{array}$$

Gaining Ratio = 1:2

Goodwill : B's share $2,00,000 \times 3/10 = 60,000$

From A $60,000 \times 1/3 = 20,000$

From C $60,000 \times 2/3 = 40,000$

$2+3+3=8$

OR

Calculation of Profit of

$$\text{Average Profit of last 3 years} = \frac{3,60,000}{3} = 1,20,000$$

$$\text{Profit for 2 months} = 120,000 \times \frac{2}{12} = \text{Rs. } 20,000$$

$$\text{Q's share of Profit} = 20,000 \times \frac{1}{5} = \text{Rs. } 4,000$$

Calculation of Goodwill

$$\text{Goodwill of the firm} = \frac{3,60,000 \times 2}{3} = \text{Rs. } 2,40,000$$

Q's share of Goodwill = Rs. 48,000

Journal Entries

June 2002	Profit & Loss Suspense A/c		4,000		
	Or				
	Deceased partner's share in Profit A/c	Dr.			
	To Q's Capital A/c			4,000	
	(Profit upto the date of death credited to Q)				(1)
	P's Capital A/c	Dr.	36,000		
	R's Capital A/c	Dr.	12,000		
	To Q's Capital A/c			48,000	
	(Share of Goodwill of Q adjusted in Gaining ratio)				(1)
	Land A/c	Dr.	1,00,000		
	To Revaluation A/c			1,00,000	
	(The value of Land increased)				(½)
	Revaluation A/c	Dr.	68,000		
	To Plant & machinery A/c			68,000	
	(To value of Plant decreased)				(½)
	Revaluation A/c	Dr.	32,000		
	To P's Capital A/c			19,200	
	To Q's Capital A/c			6,400	
	To R's Capital A/c			6,400	
	(Profit on revaluation transferred to Partner's Capital A/cs)				(1)

General Reserve A/c	Dr.	2,000		
To Q's Capital A/c			2,000	
(Share of General Reserve credited to Q's Capital A/c)				
				(1)
Q's Capital A/c	Dr.	10,000		
To Q's Drawings A/c			10,000	
(Amount of Drawings adjusted with Capital A/c)				
				(1)
Q's Capital A/c	Dr.	4,63,200		
To Q's Executors A/c			4,63,200	
(Amount of Capital balance transferred to his Executor A/c)				
				(1)
Q's Executor A/c	Dr.	1,00,000		
To Bank A/c			1,00,000	
(Cash paid to Q's Executor)				
				(1)

Working Notes

Q's Capital A/c

To Drawing A/c	10,000	By Balance b/d	4,12,800
To Q's Execution A/c	4,63,200	By P&L Suspense A/c	4,000
		By P's Capital (Goodwill)	36,000
		By R's Capital (Goodwill)	12,000
		By Revaluation (profit share)	6,400
		By General Reserve	2,000
	4,73,200		4,73,200

PART B**ANALYSIS OF FINANCIAL STATEMENTS**

16. Inflows of cash from Investing Activities (any 2 of the following)

- (i) Sale of fixed assets.
- (ii) Sale of investments
- (iii) Repayment of advances and loans made to third parties

Outflows of Cash from Investing Activities (any 2 of the following)

- (i) Purchase of fixed Assets
- (ii) Purchase of Investments
- (iii) Advances and Loans made to third parties. (1+1=2)

17. The Mutual Fund Company is a Finance Company. The Dividend received by it on the shares held in other companies is its revenue income. Therefore the dividend received by this company is cash inflow from operating activities. 2

18. Financial Analysis is a Systematic process of the critical examination of the financial information contained in the financial statements in order to understand and make decisions regarding the operations of the firm. (2 marks)

The tools used for financial analysis are as follows : (any two)

- a) Comparative statements
- b) Common-size statements
- c) Trend Analysis
- d) Ratio Analysis
- e) Cash flow Analysis (½ marks x 2) = 1 marks

(2+1= 3 marks)

19. Current Assets = Rs. 1,26,000

Current Ratio = 3/2

$$\text{Current Liabilities} = \frac{\text{CA}}{\text{Current Ratio}}$$

$$= \frac{1,26,000}{3/2} = \frac{1,26,000}{3} \times 2$$

$$= 84,000 \text{ (a)} \quad (1)$$

Liquid Assets = CA - Inventory

$$= 1,26,000 - 2,000$$

$$= 1,24,000 \text{ (b)} \quad (1)$$

Liquid Ratio = $\frac{\text{Liquid Assets}}{\text{Current Liabilities}}$

$$= \frac{1,24,000}{84,000} = \frac{31}{21}$$

$$(1+1+1=3)$$

20. Sales = 1,80,000

Rate of profit = 20% on cost

$$\text{Cost of goods sold} = \frac{100}{120} \times 1,80,000$$

$$= 1,50,000 \text{ (1)}$$

Inventory Turn Over Ratio = $\frac{\text{C.O.G.S.}}{\text{Average Inventory}}$

If Closing Stock = x

Opening Stock = x + 2000

$$\text{Average Stock} = \frac{x + x + 2000}{2} = x + 1000 \quad (1)$$

$$\text{Now} = \frac{\text{C.O.G.S.}}{\text{Average Inventory}} = 3 \quad (1)$$

$$\text{or} = \frac{1,50,000}{x + 1,000} = 3 \quad (1)$$

or $x + 1,000 = 50,000$

$x = 49,000$ i.e. Closing Stock

Opening Stock = $49,000 + 2,000$

= 51,000

(1)

(1+1+1+1=4)

21.

Cash flow from Operating Activities

Net Profit Before Tax	12,50,000		½
Add			
(i) Depreciation on Fixed Assets	25,000		½
(ii) Goodwill written off	15,000		½
(iii) Loss on Sale of a Machine	12,000		½
Operating Profit before Working			
Capital Changes	13,02,000		½
Add			
Decrease in Bills Receivable	9,500		½
Increase in Bills Payables	2,500		½
Decrease in Stock in hand	4,000		½
13,18,000	13,18,000		½
Less : Increase in Debtors	(8,800)		½
Decrease in Expenses Outstanding	(1000)		½
Cash flow from Operating Activities	13,08,200	13,08,200	½

Or

Prepare cash flow Statement of rose Ltd. form the following information for the year ended March 31, 2004

Particulars	March 31, 03	March 31, 04
Investments	1,80,000	2,40,000
Fixed assets (at Lost)	2,10,000	4,00,000
Equity share Capital	10,00,000	14,00,000
Long term team	8,00,000	4,45,00
Cash	64,000	44,000

Additional Information

- i) Cash flows from operating activities after tax and extra ordinary tens Rs. 3,80,000
- ii) Depreciation on fixed assets Rs. 85,000
- iii) Interest Received Rs. 45,000
- iv) Dividend paid during the year Rs. 1,60,000

Solution

Cash flow Statement for the year ended March 31, 2004

	Particulars	Details	Amount
A.	Cash flows from Operating Activities		3,80,000
B.	Cash flows from Investing Activites		
	Purchase of Investments	(60,000)	
	Purchase of Fixed Assets	2,75,000	
	Interest Received	45,000	
	Cash outflow from Investing Activities		(2,90,000)
C.	Cash flows from financing Activities		
	Issue of Equity shares	4, 00,000	
	Repayment of loan	(3,50,000)	

Payment of Dividend	(1,60,000)	
Cash outflow from financing Activities		(1,10,000)
Cash flows generated during the year		(20,000)
Add: Cash & cash equivalents in the beginning of the year		64,000
Cash & cash equivalents at the end of the year.		44,000

(½ mark for each amount)

(= ½ x 12= 6 marks)

PART C

COMPUTERISED ACCOUNTING SYSTEM

16. What is meant by relation or Relationship type?

2

Answer

Relation

A relation is any entity whose attributes are relevant to the business application under context. It is represented as a rectangle, and its attributes are shown as ovals

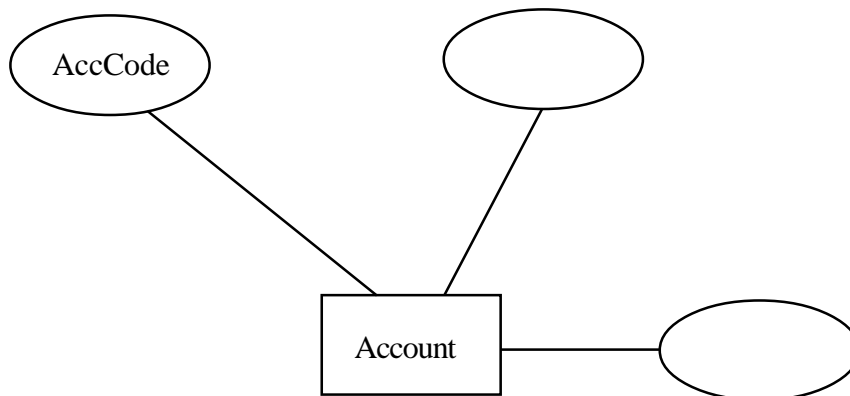

Relationship Type

It means the kind of relationship among instances (tuples) of relations (s)

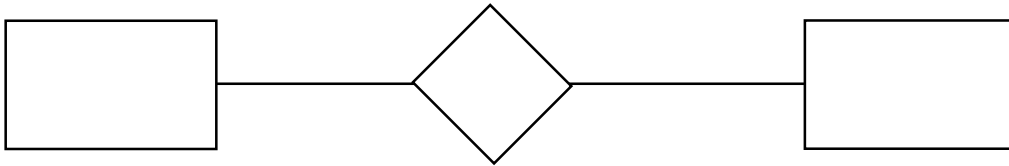

Give an example from accounting reality

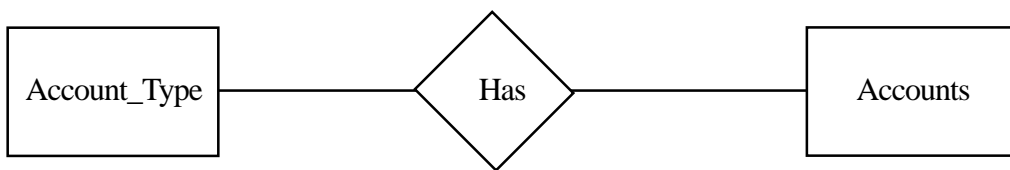

Relationship type could be :

1. one-to-one
2. one-to-many
3. many-to-many

17. Explain with one example Multi-group ledgers or Single group ledgers. (2)

Answer

An example of Multi-group ledger could be assets which could be further divided as Fixed Assets and Current Assets. Each of these could be further divided into various types.

Likewise one could give an example of single group ledger.

18. How do you transform many-to-many relationships into database tables? Illustrate (3)

Answer

Many to many relationships are not directly transferable into database tables. These relationships have to be further explored to convert these into either one-to-one or one-to-many relationships. Once that is done, these can be converted into database tables.

Give an illustration

19. Conceptualise the above accounting reality in terms of ER Model concepts

Answer.

Give details of the following :

Relations

Attributes

Relations

Relationship Type

Relationship Degree

20. Develop and depict an E R Model for this accounting reality. (3)

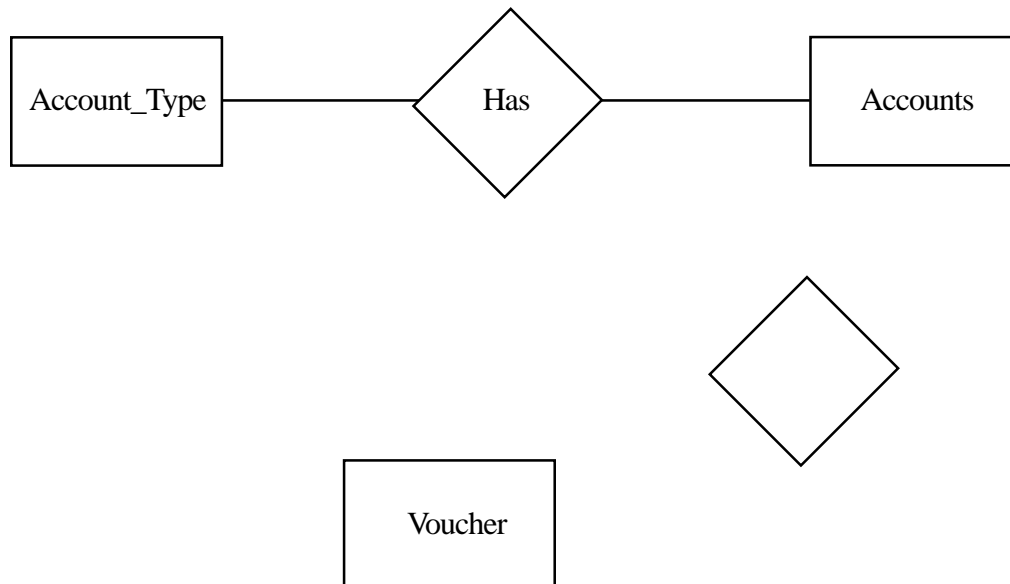

21. Show the database design in terms of relevant data tables and their inter-relationships. (4)

(Hint : Each of the entity as shown in Answer-5 will be translated into a table. Data types of the field would be appropriately chosen.

SAMPLE QUESTION PAPER - SET 1**QUESTION WISE ANALYSIS**

S. No.	Instructional Objective	Specification	Content Unit	Form of Question LA/SA/VSA	Marks Allotted	Estimated Difficulty Levels (A,B,C)
1.	Understanding	Calculates	1	VSA	2	B
2.	Knowledge	Recalls	4	VSA	2	A
3.	Understanding	Shows presentation	4	VSA	2	B
4.	Understanding	Passes Journal Entry	5	VSA	2	B
5.	Knowledge	Recalls and lists	1	SA	3	A
6.	Knowledge	Recalls	5	SA	3	A
7.	Knowledge	Recalls	2	SA	3	A
8.	Understanding	Prepares Accounts	3	SA	4	B
9.	Understanding	Passes Journal Entries	4	SA	4	B
10.	Understanding	Prepares Account	5	SA	4	B
11.	Understanding	Passes Journal Entries	5	SA	4	B
12.	Application	Prepares account	2	LA	6	C
13.	Understanding	Prepares Accounts	3	LA	6	C
14.	Understanding	Passes Journal Entries	4	LA	6	B
15.	Understanding	Prepares Accounts	2	LA	8	C
16.	Knowledge	Recalls	6.2	VSA	2	A
17.	Application	Reasons	6.2	VSA	2	C
18.	Knowledge	Recalls	6.1	SA	3	A
19.	Understanding	Finds Ratios	6.1	SA	3	B
20.	Understanding	Calculates	6.1	SA	4	B
21.	Understanding	Calculates/works Out	6.2	LA	6	B

SAMPLE QUESTION PAPER - II
SENIOR SECONDARY SCHOOL EXAMINATION

Subject : ACCOUNTANCY

Marks : 60

Class XII

Set-2

PART A : PARTNERSHIP AND COMPANY ACCOUNTS**BLUE PRINT**

Objectives	Knowledge			Understanding			Application			Total			Total
	LA	SA	VSA	LA	SA	VSA	LA	SA	VSA	LA	SA	VSA	
Form of Question/ Units	6,8	3,4	2	6,8	3,4	2	6,8	3,4	2	6,8	3,4	2	
1. Accounting for Partnership	-	-	2(1)	-	-	-	-	3(1)	-	-	3(1)	2(1)	5(2)
2. Reconstituion of Partnership firm	-	4(1)	-	8(1)	4(1)	2(1)	-	-	-	8(1)	8(2)	2(1)	18(4)
3. Dissolution of Partnership Firm	-	-	2(1)	6(1)	-	2(1)	-	-	-	6(1)	-	4(2)	10(3)
4. Accounting for Share Capital	-	4(1)	-	6(1)	4(1)	-	-	-	-	6(1)	8(2)	-	14(3)
5. Accounting for Debentures	-	-	-	6(1)	4(1)	-	-	3(1)	-	6(1)	3(1)	4(1)	13(3)
Sub Total (A)	-	8(2)	4(2)	26(4)	12(3)	4(2)	-	6(2)	-	26(4)	26(7)	8(4)	60(15)
Total (A)		12(4)		42(9)			6(2)			60(15)			

Note : Number of Question are given within brackets and total marks outside the brackets.

SAMPLE QUESTION PAPER-II
SENIOR SECONDARY SCHOOL EXAMINATION

Subject : ACCOUNTANCY

Marks:20

Class XII

Set-2

PART B : ANALYSIS OF FINANCIAL STATEMENTS**BLUE PRINT**

Objectives	Knowledge			Understanding			Application			Total			Total
	LA	SA	VSA	LA	SA	VSA	LA	SA	VSA	LA	SA	VSA	
Form of Question/ Units	6,8	3,4	2	6,8	3,4	2	6,8	3,4	2	6,8	3,4	2	
6.1 Analysis of Financial Statements	-	3(1)	-	-	4(1) 3(1)	-	-	-	-	-	10(3)	-	10(3)
6.2 Statement of Changes in Financial Position	-	-	-	6(1)	-	2(1)	-	-	2(1)	6(1)	-	4(2)	10(3)
Sub Total	-	3(1)	-	6(1)	7(2)	2(1)	-	-	2(1)	6(1)	10(3)	4(2)	20(6)
Total (B)	3(1)			15(4)			2(1)			20(6)			
GRAND TOTAL (A+B)	15(2)			57(13)			8(3)			80(21)			

Note: Number of Questions are given within brackets and total marks outside the brackets.

SAMPLE QUESTION PAPER-II
SENIOR SECONDARY SCHOOL EXAMINATION

Subject : ACCOUNTANCY

Marks:20

Class XII

Set-2

PART C : COMPUTERISED ACCOUNTING SYSTEM**BLUE PRINT**

Objectives	Knowledge			Understanding			Application			Total			Total
	LA	SA	VSA	LA	SA	VSA	LA	SA	VSA	LA	SA	VSA	
Form of Question/ Units	6	4,3	2	6	4,3	2	6	4,3	2	6	4,3	2	
6.1 Database Design for Accounting	-	-	2(1)	6(1)	-	-	-	-	-	6(1)	-	2(1)	8(2)
6.2 Overview of Computerised Accounting System	-	3(1)	-	-	-	-	-	-	2(1)	-	3(1)	2(1)	5(2)
6.3 Application of Computers in Financial Accounting	-	-	-	-	4(1) 3(1)	-	-	-	-	-	4(1) 3(1)	-	7(2)
Sub Total (C)	-	3(1)	2(1)	6(1)	7(2)	-	-	-	2(1)	6(1)	10(3)	4(2)	20(6)
Total (C)	5(2)			13(3)			2(1)			20(6)			
GRAND TOTAL (A+C)	17(6)			55(13)			8(2)			80(21)			

SAMPLE QUESTION PAPER-II**ACCOUNTANCY****CLASS XII****Maximum Marks : 80****Time allowed : 3 hrs.****General Instructions :**

- (i) *This question paper contains three parts A, B and C*
- (ii) *Part A is compulsory for all candidates.*
- (iii) *Candidates can attempt only one part of the remaining Part B and C.*
- (iv) *All parts of a question should be attempted at one place.*

PART-A**PARTNERSHIP AND COMPANY ACCOUNTS**

- 1 A & B are partners sharing Profit or Loss in the ratio of 3:2 having capital balances of Rs. 50,000 & Rs. 40,000 on 1.4.2003. On 1st July, 2003 A introduced Rs. 10,000 as his additional capital whereas B introduced only Rs. 1000. If the interest on capital is allowed to partners @ 10% p.a. calculate the interest on capital if the financial year closes on 31st of March every year. 2
2. A and B share Profits in the ratio of 8:7. C is admitted to partnership firm for 1/5th share. Find out the new profit sharing ratio. 2
- 3 Give four differences between dissolution of Patnership and dissolution of Partnership Firm. 2
- 4 Pass the Journal entries for the following at the time of dissolution of a firm :
 - (i) Sale of Assets = Rs. 50,000
 - (ii) Payment of Liabilities = Rs.10,000
 - (iii) A commission of 5% allowed to Mr. X a partner, on sale of assets. 2
5. What is 'Partnership deed'? Give any four important contents of a Partnership deed. 3
- 6 On June 1, 2003 Moon Ltd. purchased 5,000 8% Debentures of Rs. 100 each at the rate of Rs. 98. The interest is payable on March 31 and September 30 every year. Calculate the real price of the debentures acquired if the price quoted above is (i) ex-interest and (ii) cum-interest. 3

- 7 What is the objective of taking a joint life policy by the partners? Explain two methods for recording the premium paid on Joint Life Policy?
- 8 X and Y are partners in a firm sharing profits in the ratio of 2:3. The Balance Sheet of the firm as at March 31, 2003 is given below :

Balance sheet of X and Y as at March 31, 2003

Liabilities	Amount Rs.	Assets	Amount Rs.
Capitals :		Land	5,00,000
X 8,00,000		Buildings	6,00,000
Y 12,00,000	20,00,000	Plant	8,00,000
Creditors	3,10,000	Furniture	1,20,000
Outstanding Expenses	70,000	Stock	1,80,000
		Debtors	1,50,000
		Cash	30,000
	23,80,000		23,80,000

The partners decided to share profit in equal ratio w.e.f. April 1, 2003. The following adjustments were agreed upon :

- (i) The Goodwill of the firm was valued at Rs. 4,00,000 but it was not to appear in books.
- (ii) Land was valued at Rs. 8,00,000, Plant at Rs. 7,20,000 and Furniture at Rs. 1,00,000 and were to appear at revalued amounts in the balance sheet.

Pass the necessary Journal entries to give effect the above. 4

- 9 (a) According to Section 79 of Company's Act, 1956, what are the two provision when companies cannot issues shares at discount? 2
- 10 (a) Mohan Ltd. purchased a machine form Atlas Ltd. for Rs. 5,40,000. It was decided to make the payment by issue of equity shares of Rs 10 each at a discount of 10%. Give necessary journal entries in the books of Mohan Ltd.
- (b) KMHD Ltd. forfeited 200 shares of Rs. 100 each issued at a discount of 5% on which Rs. 50 per share has been called and Rs. 6,000 has been paid. The Company then re-issued the above mentined shares to Mr. Singh upon payment of Rs. 18,000 credited as fully paid. Pass the Journal entries for forfeiture and re-issue of the shares. 2

- 11 White Ltd. issued 8,00,000 8% Debentures of Rs. 100 each redeemable at a premium of 10%. According to the terms of redemption the company redeemed 25% of the above debentures by converting them into shares of Rs. 50 each issued at a premium of 60%

Pass Journal entries regarding redemption of debentures.

4

- 12 A, B and C were the Partners sharing profits and losses in their capital ratio.

Balance sheet as on 31st March, 2003

Liabilities	Amount Rs.	Assets	Amount Rs.
Creditors	57,400	Plant & Machinery	43,600
Joint Life Policy Reserve	15,000	Stock	16,000
A 30,000		Investments	47,600
B 20,000		Joint Life Policy Investment	15,000
C 10,000	60,000	Furniture	3,700
		Cash at Bank	6,500
	1,32,400		1,32,400

The firm was dissolved on the above date.

A took over Investments & Stock at Rs. 41,000. J. L. Policy was realised at surrender value. Furniture was sold at Book Value. Plant & Machinery were realised for Rs. 82,040. Creditors were paid in full settlements.

Pass Journal entries.

6

OR

P & R were Partners in a firm sharing profits & losses in the ratio of 3:2. They agreed to dissolve their Partnership firm on 31st March, 2003. P was deputed to realise the Assets and pay the liabilities. He was paid Rs. 1000 as commission for his services. The financial position of the firm was as follows :

Balance sheet as on 31st March, 2003

Liabilities	Amount Rs.	Assets	Amount Rs.
Creditors	10,000	Land, Building & Machineries	30,000
Bills Payable	3,700	Stock	5,500
Investment Fluctuation fund	4,500	Investments	15,000
Capital		Account Receivable	
P 37,500			7,100
Q <u>15,000</u>	52,500	Less Provision <u>-450</u>	6,650
		Cash	13,550
	<u>70,700</u>		<u>70,700</u>

P took over investments for Rs. 12,500. Stock and debtors were realised Rs. 11,500. Plant and Machine were sold to R for 22, 500 for cash. Realisation expenses paid Rs. 900

Prepare Realisation A/C and Partners's Capital Accounts to close the Books of the firm. 6

- 13 P & J Ltd. company was established with an autorised capital of Rs. 10,00,000 divided into shares of Rs. 10 each.

32,000 shares were issued and subscribed for by the public payable as Rs. 4 on application, 2 on allotment, 2 on first call and 2 on final call.

The amount received in respect of these shares were as follows :

on 24,000 shares full amount called.

on 5,000 shares Rs. 8 per share

on 2,000 shares Rs. 6 per share

on 1,000 shares Rs. 4 per share

The Directors forfeited 3,000 shares on which less than Rs. 8 per share has been paid and reissued to Kamal at Rs. 8 per share as fully paid.

Pass Journal Entries in the books of the Company for the record of above transactions. 6

14 Given below is the Balance sheet of PK Ltd. as at March 31, 2003

Liabilities	Amount Rs.	Assets	Amount Rs.
Share Capital		Fixed Assets	80,00,000
Authorised Shares of Rs. 50 Each	5,00,00,000	Current Assets	90,50,,000
Issued, Called up and paid up shares of Rs. 50 each	1,00,00,000	Own Debentures (face value Rs.9,00,000)	8,50,000
General Reserve	20,00,000	Cash at Bank	6,00,000
8% Debentures	40,00,000		
Sundry Creditors	25,00,000		
	1,85,00,000		1,85,00,000

The company decided the following :

- (i) To redeem all the 8% debentures due for redemption on September 30, 2003 and also to cancel its own debenture.
- (ii) To pay interest to debentures holders due on the date of redemption.

Pass necessary Journal entries on September 30, 2003.

15 L and M are partners sharing profits in ratio of 5:3. The balance sheet of the firm as at March 31, 2003 is given below :

Balance sheet of L and M as at March 31, 2003

Liabilities	Amount Rs.	Assets	Amount Rs.
Capitals:		Land	6,00,000
L 12,85,000		Buildings	8,80,000
M 7,16,000	20,01,000	Other Fixed Assets	3,90,000
Reserve Fund	2,40,000	Stock	1,98,000
S. Creditors	1,49,000	Debtors	1,83,000
		Cash in hand and at bank	1,39,000
	23,90,000		23,90,000

On April 1, 2003, N is admitted into partnership on the following terms :

- (a) L, M and N will share profits in the ratio of 7:5:3.
- (b) The Assets were revalued for the purpose of admission : land Rs. 7,50,000, Buildings Rs. 8,00,000.
- (c) Goodwill of the firm was valued at Rs. 3,60,000. N was to bring his share of goodwill in cash which was to be retained in the business.
- (d) N has to bring Rs. 6,00,000 towards his share of capital.

Prepare Revaluation A/c, Capital A/c, Cash A/c and Balance Sheet of the reconstituted firm. 8

OR

The Balance Sheet of J, K and L, who were sharing profits in the ratio of 5:3:2, is given below as at March 31, 2003.

Liabilities	Amount Rs.	Assets	Amount Rs.
Capitals:		Land	1,85,000
J 5,78,800		Buildings	2,87,000
K 3,47,800		Plant & Machinery	3,86,000
L 2,37,900	11,64,500	Stock	1,85,000
Sundry Creditors	78,600	Debtors	92,100
		Cash	1,08,000
	12,43,100		12,43,100

L retires on the above date and the following adjustments in the value of assets and liabilities were agreed upon :

- (a) Land was under valued by Rs. 1,20,000, Plant & Machinery overvalued by Rs. 35,000.
- (b) Provision for doubtful debt was required for Rs. 6,000.
- (c) Goodwill was valued at Rs. 3,00,000 and was to be adjusted against the capital of remaining partners.

L was paid Rs. 75,000 immediately and the balance amount was to be transferred to his loan account.

Prepare Cash A/c, Revaluation A/c, Capital and Balance Sheet of the reconstituted firm on the above date.

PART B**ANALYSIS OF FINANCIAL STATEMENT**

- 16 Calculate the cash flow from the given information:
- (i) Investments at the beginning of the period Rs. 40,000
 - (ii) Investments at the end of the period Rs. 30,000
 - (iii) During the year company had sold 30% of its investments held in the beginning of the period at a profit of Rs. 6,000. (2)
17. Classify the following into operating, investing and financing activities.
- (a) Issue of Share Rs. 2,00,000
 - (b) Receipt of interest on Investment by a manufacturing Co. Rs. 5,000
 - (c) Sale of Goods Rs. 5,00,000
 - (d) Receipt of interest on investment by a bank.
18. Prepare Comparative Income Statement from the following information:

Particulars	2002 (Rs.)	2003 (Rs.)	
Net sales	4,12,000	3,20,000	
Less Cost of Goods Sold	3,12,000	2,30,000	
Gross Profit	1,00,000	90,000	
Less Administrative Expenses	25,000	18,000	
Profit before Tax	75,000	72,000	
Provision for Tax 40%	30,000	28,800	
Net profit after Tax	45,000	43,200	3

19. What is the importance of Financial Statement analysis for creditors and bankers? 3
20. A company had a liquid ratio of 1.5 and current ratio of 2 and inventory turnover ratio 6 times. It has total current assets of Rs. 8,00,000 in the year 2003. Find out annual sales if goods are sold at 25% Profit on Cost. 4

21. From the following information, prepare Cash Flow Statement as on March 31, 2002

Liabilities	2001	2002	Assets	2001	2002
Share Capital	80,000	1,60,000	Goodwill	30,000	20,000
General Reserve	4,000	10,000	Building	40,000	90,000
Profit & Loss A/c	50,000	60,000	Machinery	49,000	98,000
Creditors	5,000	3,000	Debtors	15,000	20,000
Bills payable	15,000	25,000	Cash in hand	20,000	30,000
	1,54,000	2,58,000		1,54,000	2,58,000

(i) Depreciation provided during the year on machine was Rs 10,000

6

OR

From the following information prepare Cash flow statement as on March 31, 2003

Balance Sheets as on March 31, 2002 & 2003

Liabilities	2002 Rs.	2003 Rs.	Assets	2002 Rs.	2003 Rs.
Share Capital	2,80,000	2,80,000	Plant	1,56,000	1,38,000
General reserve	50,000	56,000	Less: Accumulated	(56,000)	(32,000)
P & C A/c	50,000	54,000	Depreciation	1,00,000	1,06,000
Bank Overdraft	10,000	20,000	Investment	1,90,000	1,80,000
Provision for doubtful debts	20,000	30,000	Debtors	20,000	84,000
			Cash	60,000	70,000
			Preliminary Expenses	40,000	-
	4,10,000	4,40,000		4,10,000	4,40,000

Additional Information

During the year, a part of the machinery costing Rs. 60,000 on which accumulated depreciation was Rs. 25,000, was sold for Rs. 30,000.

PART C**COMPUTERISED ACCOUNTING SYSTEM**

16. Explain the concept of Data Model with the help of an example. 2
17. Explain with one example DML or DCL. 2
18. Write a series of queries to process the transaction data in such a manner as to result into information on Trial Balance. 3
19. Formulate the SQL statement for answering the following queries for an assumed design of an Accounting Reality.
- (a) List the transaction details of accounts which have been credited during the month of August, 2003
 - (b) List all the transacted accounts with the amounts by which they have been debited and also the amount with which they have been credited.
 - (c) List the amount of expenses authorised by each of the employees. (1+1+1)
20. Formulate the SQL statements for answering the following queries for an assumed design of an Accounting Reality:
- (a) List item wise the quantity sold during the month of September, 2003
 - (b) Find the Minimum and Maximum rate at which each item of goods has been purchased during the period October, 2003.
 - (c) Make a list of Invoice No., Date and Amount of purchases during the period April 1, 2003 to March 31, 2004, grouping them month-wise. (1+1+2)
21. Explain the concept of Relationship Degree. How is it different from Relationship Type? Give one example for each. 6

MARKING SCHEME
SAMPLE QUESTIONG PAPER II
ACCOUNTANCY

PART A: PARTNERSHIP AND COMPANY ACCOUNTS

1. Statement showing calculation of interest

Particulars	A Rs.	B Rs.
1 Interest on capital balance on April 1, 2003:		
A 50,000 x $\frac{10}{100}$	5,000	
B 40,000 x $\frac{10}{100}$		4,000
2 Add: Interest on Additional Capital:		
A 10,000 x $\frac{10}{100}$ x $\frac{9}{12}$	750	
B 1,000 x $\frac{10}{100}$ x $\frac{9}{12}$		75
Total interest Payable	5,750	4,075

Alternate Solution:

(1+1=2)

$$\begin{aligned}
 \text{Interest on Capital to A} &= \left(50,000 \times \frac{10}{100} \times \frac{3}{12} \right) \\
 &+ \left(60,000 \times \frac{10}{100} \times \frac{9}{12} \right) \\
 &= 1,250 + 4,500 \\
 &= 5,750
 \end{aligned}$$

3. Court's intervention	Court does not intervene because partnership is dissolved by mutual agreement and through the process of reconstitution	A firm can be dissolved by the order of the court
4. Economic relationship	Economic relationship may remain or may not remain the same	Economic relationship between the partners comes to an end
5. Closure of books	Closure of account books is not required because business is not terminated	All books of accounts are closed

$$\frac{1}{2} \times 4 = 2$$

4.	Particulars	LF	Debit Rs.	Credit Rs.
(i)	Bank A/c Dr. To Realization A/c (Being Assets sold on dissolution of the firm)		50,000	50,000 $\frac{1}{2}$
(ii)	Realisation A/c Dr. To Bank A/c (Being liabilities paid on dissolution of the firm)		10,000	10,000 $\frac{1}{2}$
(iii)	Realisation A/c Dr. To 'X' (A commission of 5% on assets realised, allowed to 'X')		2,500	2,500 (1)

$$\text{Total} = \frac{1}{2} + \frac{1}{2} + 1 = 2$$

5. The partnership deed is a written agreement between two or more persons, for managing the affairs of a partnership firm.

Important contents of partnership deed (any four) :

1. Name of the firm,
2. Names and addresses of all partners,
3. Nature and place of the business,
4. Date of commencement of partnership,
5. Duration of partnership, if any,
6. Amount of capital contributed or to be contributed by each partner,
7. Rules regarding operation of bank accounts,
8. Ratio in which profits are to be shared,
9. Interest, if any, on partner's Capital and drawings,
10. Interest on loan by the partner(s) to the firm,
11. Salaries, commission etc., if payable to any partner(s),
12. The safe custody of the books of accounts and other documents of the firm,
13. Mode of auditor's appointment, if any,
14. Rules to be followed in case of admission, retirement and death of a partner,
15. Settlement of accounts on dissolution of the firm,
16. Mode of settlement of disputes among the partners,
17. Any other 4 x ½ = (2)

(1 + 2 = 3)

6. (i) Real Price if the Price is Ex-interest

On June 1, 2003 Ex. interest Price = Rs. 98

Real Price = Ex-interest Price

Therefore Real Price = Rs. 98 (1½)

- (ii) Real Price if the price is Cum-Interest

On June 1, 2003 Cum-interest Price = Rs. 98

Real Price = Cum Interest Price

Less Accrued interest

Accrued interest for 2 months from March 31 to June 1, 2003

$$= 100 \times \frac{8}{100} \times \frac{2}{12} = \text{Rs. } 1.33$$

Therefore Real Price = Rs. 98 - 1.33

= Rs. 96.67 (1½)

Total = (1½+1½ = 3)

7. The objective of J.L.P. is to ensure liquidity in the firm to settle the claim of the retiring or deceased partner.

Method of treatment :

1. When Premium paid is treated as an expense.
2. When Premium paid is treated as an asset at an amount equal to the surrender value of J.L.P.

Explain with example (1+1½+1½) = 4

8. Working notes : 2

$$\text{Gain of X} = \frac{1}{2} - \frac{2}{5} = \frac{5-4}{10} = \frac{1}{10}$$

$$\text{Sacrifice of Y} = \frac{3}{5} - \frac{1}{2} = \frac{6-5}{10} = \frac{1}{10}$$

$$\text{Share of Goodwill to be given by X to Y} = \text{Rs. } 4,00,000 \times \frac{1}{10} = \text{Rs. } 40,000$$

$$\begin{aligned} \text{Profit on revaluation of land} &= \text{Rs. } 8,00,000 - \text{Rs. } 5,00,000 \\ &= \text{Rs. } 3,00,000 \end{aligned}$$

$$\begin{aligned} \text{Loss on revaluation of plant} &= \text{Rs. } 8,00,000 - \text{Rs. } 7,20,000 \\ &= \text{Rs. } 80,000 \end{aligned}$$

$$\begin{aligned} \text{Loss on Revaluation of Furniture} &= \text{Rs. } 1,20,000 - \text{Rs. } 1,00,000 \\ &= \text{Rs. } 20,000 \end{aligned}$$

$$\text{Profit on revaluation} = \text{Rs. } 3,00,000 - \text{Rs. } 80,000 - \text{Rs. } 20,000 = \text{Rs. } 2,00,000$$

Joint Entries

1.	X's Capital To Y's Capital (Share of goodwill given by X to Y on change in their profit share ratio)	Dr.	40,000		
				40,000	(1)
2.	Land To Revaluation (Profit on revaluation of land recorded)	Dr.	3,00,000		
				3,00,000	(1)
3.	Revaluation To Plant To Furniture (Loss of revaluation of plant and furniture recorded)	Dr.	1,00,000		
				80,000 20,000	(1)
4.	Revaluation To X's Capital To Y's Capital (Profit on revaluation distributed among X and Y)	Dr.	2,00,000		
				80,000 1,20,000	(1)

Total = 4

9. (a) Two provisions of Section 79 of Companies Act 1956

(i) A New Company cannot issue shares at a discount; and

(ii) A New class of shares cannot be issued at a discount.

(b) Distinction between Capital Reserve and Reserve Capital

$\frac{1}{2} + \frac{1}{2} = 1$

Reserve Capital	Capital Reserve
1. It is a part of uncalled capital of the company	1. It is the remaining part of shares forfeited A/c after the re-issue of forfeited shares ($\frac{1}{2}$)
2. It is never shown specifically in the Balance Sheet of the Company	2. It is shown clearly in the liabilities side of the company's Balance Sheet under the heading "Reserve of Surplus" ($\frac{1}{2}$)

$1 + 1 = 2$

10 (a)

Journal

Date	Particulars	LF	Debit Rs.	Credit Rs.
	Machine A/c Dr.		5,40,000	
	To Atlas Ltd. (Machine purchased)			5,40,000 ($\frac{1}{2}$)
	Atlas Ltd. Dr.		5,40,000	
	Discount on Issue of Shares Dr.		60,000	
	To Equity share Capital (60,000 equity shares issued to settle Atlas Ltd. account)			6,00,000 ($1\frac{1}{2}$)

Working Notes

$$\text{No. of shares to be issued} = \frac{5,40,000}{9}$$

$$= 60,000$$

$$(\frac{1}{2} + 1\frac{1}{2} = 2)$$

10.(b)

KMHD Ltd.

		Debit Rs.	Credit Rs.	
Share Capital A/c	Dr.	10,000		
To Share forfeited A/c			6,000	
To Calls in Arrears A/c			3,000	
To Discount on Issue of Shares A/cs (Being 200 shares forfeited and Rs. 3,000 being calls in arrears)			1,000	(½)
Bank A/c	Dr.	18,000		
Discount A/c	Dr.	1,000		
Shares forfeited A/c	Dr.	1,000		
To Share Capital A/c (Being 200 shares reissued @ Rs. 90)			20,000	(½)
Share forfeited A/c	Dr.	5,000		
To Capital Reserve A/c (Being the balance amount of shares forfeited and transferred to Capital Reserve A/c)			5,000	(½)

Total = 2

11.	8% Debentures A/c	Dr.	2,00,00,000		
	Premium of Redemption of Debentures A/c	Dr.	20,00,000		
	To Debenture Holders A/c (Being the amount of 25% of Debentures and premium on redemption to be converted into shares)			2,20,00,000	(1½)

Debenture holders A/c	Dr.	2,20,00,000	
To Share Capital A/c			1,37,50,000
To Security Premium A/c			82,50,000
(Being issue of 2,75,000 shares of Rs. 50 each at premium of 60% to the debenture holders on conversion of 2,00,000 debentures)			

Working Note :

- (a) Amount to be converted = Rs. 2,20,00,000
- (b) Issue price of a share of Rs. 50 at a premium of 60% = Rs. 50 + Rs. 30 = Rs. 80
- (c) Number of shares to be issued on conversion (a/b) = $\frac{2,20,00,000}{80}$ 2,75,000 shares of Rs. 50 each (1)
- Total = 4

12 Journal

Date	Particulars	LF	Debit Amount Rs.	Credit Amount Rs.
	Realisation A/c	Dr.	1,25,900	
	To Plant & Machinery A/c			43,600
	To Stock A/c			16,000
	To Investment A/c			47,600
	To Joint Life Policy Investment			15,000
	To Furniture			3,700
	(Transfer of sundry assets to Realisation A/c)			(1/2)

Creditors A/c	Dr.		57,400	
Joint Life Policy Reserve A/c	Dr.		15,000	
To Realisation A/c				72,400
(Transfer of sundry liabilities to Realisation A/c)				(½)
A's Capital A/c	Dr.		41,000	
To Realisation A/c				41,000
(Being investments and stock taken over by A)				(1)
Bank A/c	Dr.		1,00,740	
To Realisation A/c				1,00,740
(Being assets realised – JLP, Furniture and Plant)				(1)
Realisation A/c	Dr.		57,400	
To Bank A/c				57,400
(Being creditors paid)				(1)
Realisation A/c	Dr.		30,840	
To A's Capital A/c				15,420
To B's Capital A/c				10,280
To C's Capital A/c				5,140
(Being profit on realisation credited to to partners in their profit Sharing ratio, i.e. 3:2:1)				(1)

Journal

Date	Particulars	L.F.	Dr. Amount (Rs.)	Cr. Amount (Rs.)
	A's Capital A/c	Dr.	4,420	
	B's Capital A/c	Dr.	30,280	
	C/s Capital A/c	Dr.	15,140	
	To Bank			49,840
	(Being final Payment to Partners)			

(Realisation A/c and Bank A/c may be prepared as working notes - no marks Total = 6

OR

Realisation A/c

Particulars	Amount Rs.	Particulars	Amount Rs.
To Plant & Machinery	30,000	By Provision for doubtful debts	450
To Stock	5,500	By Creditors	10,000
To Investments	15,000	By Bills Payable	3,700
To Accounts Receivable	7,100	By Investment Fluctuation Fund	4,500
To P's Capital A/c (Commission)	1,000	By P's Capital A/c (Investments)	12,500
To Cash (Realisation expenses)	900	By Cash (Stock + Debtors)	11,500
To Cash (Creditors + Bill Payable)	13,700	By Cash (Machinery)	22,500
		By Loss transferred to	
		P's Capital A/c	4,830
		R's Capital A/c	3,220
	73,200		8,050
			73,200

(4)

Partner's Capital A/c

Particulars	P	R	Particulars	P	R
Realisation A/c	12,500		Balance b/d	37,500	15,000
Realisation A/c	4,830	3,220	Realisation A/c	1,000	
Cash	21,170	11,780			
	38,500	15,000		38,500	15,000

(1 mark for each Partner's Capital A/c)

(Cash A/c may be prepared as working note - but no marks)

4 + 2 = 6

13.	Bank A/c	Dr.	1,28,000			
	To Share Applications A/c			1,28,000		
	(Being cash received @ Rs. 4 per share on application for 32,000 shares)					½
	Share Application A/c	Dr.	1,28,000			
	To Share Capital A/c			1,28,000		
	(Being the share application money received transferred to share capital account)					½
	Share Allotment A/c	Dr.	64,000			
	To Share Capital A/c			64,000		
	(Being share allotment money @ Rs. 2 per share due on 32000 shares)					½
	Bank A/c	Dr.	62,000			
	Calls-in-Arrears	Dr.	2,000			
	To Share Allotment A/c			64,000		
	(Being cash received on 31,000 shares on account of allotment @ Rs. 20 arrears on 1000 shares)					½

Share First Call A/c	Dr.	64,000		
To Share Capital A/c			64,000	
(Being First Call money @ Rs. 2 on Rs. 32,000 shares due)				
Bank A/c	Dr.	58,000		
Calls-in-Arrears A/c	Dr.	6,000		
To Share First Call A/c			64,000	
(Being amount received on 29,000 shares. Arrears on 3000 shares)				
Share Second & Final Call A/c	Dr.	64,000		
To Share Capital A/c			64,000	
(Being second call money due @ 2 per share on 32,000 shares)				
Bank A/c	Dr.	48,000		
Call-in-Arears	Dr.	16,000		
To Share Second and Final Call A/c			64,000	
(Being the amount received @ Rs. 2 on 24,000 shares and calls in arrears on 8,000 shares)				
Shares Capital A/c	Dr.	30,000		
To Share forfeited A/c			16,000	
To Calls-in-Arrears A/c			14,000	
(Being 3,000 shares forfeited on which less than Rs. 8 has been received. Calls in arrear on 2,000 shares Rs. 8,000 and on 1,000 shares Rs. 6,000)				

1/2

1/2

1/2

1/2

Bank A/c	Dr.	24,000		
Shares forfeited A/c	Dr.	6,000		
To Share Capital				30,000
(Being 3,000 shares issued to Kamal @ Rs. 8 per share fully paidup)				(½)
Share forfeited A/c	Dr.	10,000		
To Capital Reserve				10,000
(Being the remaining amount of shares forfeited account transferred to capital reserve)				(1)

Total = 6

14.

2003 Sep. 30	8% Debenture A/c	Dr.	40,00,000	
	To Own Debentures A/c			8,50,000
	To Gain on Cancellation of Debentures A/c			50,000
	to Debenture holders A/c			31,00,000
	(Being own debentures cancelled and the amount payable to debenture holders on redemption of other debenture) (Two entries can also be passed)			
	Debenture holders A/c	Dr.	31,00,000	
	To Bank A/c			31,00,000
	(Being the amount paid to debenture holders on redemption)			

Gain on Cancellation of Debentures A/c	Dr.	50,000	
To Capital Reserve A/c			50,000
(Being the gain on cancellation of debentures account transferred to Capital Reserve)			
(a) Interest on Debentures A/c	Dr.	1,24,000	
To Debenture holders A/c			1,24,000
(Being interest payable to debenture holders other than own Debentures held)			
(b) Debentures holders A/c	Dr.	1,24,000	
To Bank A/c			1,24,000
(Being interest paid to Debenture holders)			
(c) Interest on Debentures A/c	Dr.	36,000	
To Interest on own Debenture A/c			36,000
(Being interest on own debentures for six months)			

Note : Entries (a) and (b) can be combined.

1 mark for each entry

Total = 6

15.

Revaluation Account

Dr.		Cr.	
Particulars	Rs.	Particulars	Rs.
Buildings	80,000	By Land	1,50,000
L's Capital	43,750		
M's Capital	26,250		
	1,50,000		1,50,000

(2 marks)

Capital Accounts

Dr.

Cr.

	L Rs.	M Rs.	N Rs.		L Rs.	M Rs.	N Rs.
To Balance c/d	15,35,750	8,47,250	6,00,000	By Balance b/d	12,85,000	7,16,000	
				By Reserve Fund	1,50,000	90,000	
				By Premium (19.5)	57,000	15,000	
				By Revaluation A/c	43,750	26,250	
				By Cash			6,00,000
	15,35,750	8,47,250	6,00,000		15,35,750	8,47,250	6,00,000

(3 marks)

Cash A/c

Dr.

Cr.

To Balance b/d	1,39,000	By Balance c/d	8,11,000
To N's Capital	6,00,000		
To Premium	72,000		
	8,11,000		8,11,000

Balance Sheet of L, M and N as at March 31,2003

Capitals : L	15,35,750		Land	7,50,000
M	8,47,250		Building	8,00,000
N	6,00,000	29,83,000	Other Fixed Assets	3,90,000
S. Creditors		1,49,000	Stock	1,98,000
			DSS	1,83,000
			Cash in hand and at Bank	8,11,000
		31,32,000		31,32,000

(2 marks)

Total = 8

Working Note :

1. Sacrifice made by :

$$L = \frac{5}{8} - \frac{7}{15} = \frac{75-56}{120} = \frac{19}{120}$$

$$M = \frac{3}{8} - \frac{5}{15} = \frac{45-40}{120} = \frac{5}{120}$$

$$\text{Sacrifice Ratio: } L : M \\ 19 : 5$$

2. Amount of Premium to be brought by N :

$$3,60,000 \times \frac{1}{5} = 72,000$$

3. (i) Share of L in Premium brought by N :

$$\frac{19}{24} \times 72,000 = 57,000$$

(ii) Share of M in Premium brought by N :

$$\frac{5}{24} \times 72,000 = 15,000$$

OR

Revaluation A/c

Particulars	Rs.	Particulars	Rs.
To Plant & Machinery	35,000	By Land	1,20,000
To Provision for doubtful debts	6,000		
To J	39,500		
K	23,700		
L	15,800		
	79,000		
	1,20,000		1,20,000

Capital A/c

Dr.

Cr.

Particulars	J	K	L	Particulars	J	K	L
To L (in gaining ratio 5:3)	37,500	22,500	—	By balance b/d	5,78,800	3,47,800	2,37,900
To Cash	-	-	75,000	By Revaluation A/c	39,500	23,700	15,800
To L's Loan A/c	-	-	2,38,700	By J (gaining ratio)	-	-	37,500
To balance c/d	5,80,800	3,49,000	-	By K (gaining ratio)	-	-	22,500
	6,18,300	3,71,500	3,13,700		6,18,300	3,71,500	3,13,700

Cash A/c

Dr.

Cr.

Paticulars	Rs.	Particulars	Rs.
To balance b/d	1,08,000	By L	75,000
		By balance c/d	33,000
	1,08,000		1,08,000

Balance Sheet as at March 31,2003

Liabilities	Rs.	Assets	Rs.
Capitals		Land	3,05,000
J	5,80,800	Buildings	2,87,000
K	<u>3,49,000</u>	Plant & Machinery	3,51,000
L's Loan A/c	2,38,700	Stock	1,85,000
Creditors	78,600	Debtors	86,100
		Cash	33,000
	12,47,100		12,47,100

Workings

Book value of investments sold	12,000
(30% of Rs. 40,000)	
Add Profit	<u>6,000</u>
Sale value of investments	18,000
Investments at the end of the period	30,000
Less : Book value of unsold investment	28,000
(70 of Rs. 40,000)	
Investment purchased	<u>2,000</u>

Answer

Cash inflow Rs. 18,000 (I)

Cash outflow Rs. 2,000 (I)

2 marks

17. (a) Financing Activity
 (b) Investing Activity
 (c) Operating Activity
 (d) Operating Activity

 $\frac{1}{2} \times 4 = 2$ 18. **Comparative Income Statement for the year ending.... 2002 & 2003**

Particulars	2002 (Rs.)	2003 (Rs.)	Absolute change (Rs.)	Percentage change (%)
Net Sales	4,12,000	3,20,000	(92,000)	22.33
Less : Cost of Goods sold	3,12,000	2,30,000	(82,000)	26.28
Gross Profit	1,00,000	90,000	(10,000)	10.00
Less : Administrative Expenses	25,000	18,000	(7,000)	28.00
Profit before Tax	75,000	72,000	(3,000)	4.00
Provision for Tax @ 40%	30,000	28,800	(1,200)	4.00
Net Profit after Tax	45,000	43,200	(1,800)	4.00

 $\frac{1}{2}$ mark for each correct step $= \frac{1}{2} \times 6 = 3$

Ignore last step

19. Financial statements convey about the financial performance and financial position of a business entity. Financial statement analysis has significance for bankers and creditors since they are interested in assessing whether the interest on credit extended by them will be received periodically and the Company will be able to repay the amount advanced or not. Financial statement analysis helps in assessing the liquidity, solvency, profitability and efficiency of the enterprise.

(3)

$$20. \text{ Current Ratio} = 2$$

$$\text{Current Assets} = \text{Rs. } 8,00,000$$

$$\text{Current Ratio} = \frac{\text{Current Assets}}{\text{Current Liabilities}}$$

$$2 = \frac{\text{Rs. } 8,00,000}{\text{Current Liabilities}}$$

$$\text{or, Current liabilities} = \frac{\text{Rs. } 8,00,000}{2} \quad (1)$$

$$= 4,00,000$$

$$\text{Liquid ratio} = \frac{\text{Liquid Assets}}{\text{Current Liabilities}}$$

$$1.5 = \frac{\text{Liquid Assets}}{4,00,000}$$

$$\begin{aligned} \text{or Liquid Assets} &= 1.5 \times 4,00,000 \\ &= \text{Rs. } 6,00,000 \end{aligned}$$

$$\text{Inventory} = \text{Current Assets} - \text{Liquid Assets}$$

$$= \text{Rs. } 8,00,000 - \text{Rs. } 6,00,000$$

$$= \text{Rs. } 2,00,000 \quad (1)$$

$$\text{Inventory Turnover Ratio} = \frac{\text{Cost of goods sold}}{\text{Average inventory}}$$

$$6 = \frac{\text{Cost of goods sold}}{2,00,000}$$

$$\begin{aligned} \text{or, Cost of Goods sold} &= 6 \times 2,00,000 \\ &= \text{Rs. } 12,00,000 \end{aligned} \quad (1)$$

Now, if goods are sold at 25% profit on cost then it means that if cost is Rs. 100, sales are Rs. 125

$$\begin{aligned} \text{so, if cost is Rs. } 12,00,000, \text{ sales are} &= \frac{125}{100} \times 12,00,000 \\ &= \text{Rs. } 15,00,000 \end{aligned}$$

Annual Sales are Rs. 15,00,000 (Total = 4)

21. Balance of P & L as at Dec. 31, 2002	60,000
Add Transfer to G.R. during the year (10,000-4,000)	6,000
	66,000
Less Balance of P & L as at Dec., 31, 2001	50,000
Net Profit before Tax	16,000

Machinery A/c

To Balance b/d	49,000	By Depreciation Expense	10,000
To Cash (purchase of Machinery) (Bal. fig.)	59,000	By Balance c/d	98,000
	1,08,000		1,08,000

Statement of Cash Flows

	Rs.	Rs.
(A) <u>Cash flow from Operating Activities</u>		
(a) Net Profit before Tax	16,000	
Add Dep. on Machinery	10,000	
Goodwill written-off	10,000	

(b) Operating Profit before Working Capital Changes	36,000		
Add Increase in B. Payable	10,000		
Less Decrease in Creditors	(2,000)		
Less Decrease in Debtors	<u>(5,000)</u>		
(c) Net Cash from Activities		39,000	3
(B) Cash flow from Investing Activities			
Cash used for purchase of Building	(50,000)		
Cash used for purchase of Machinery	<u>(59,000)</u>		
Net Cash used for Investing Activities		(1,09,000)	(1)
(C) Cash flow from Financial Activities			
Cash from issue of share Capital	<u>80,000</u>		
Net Cash from Financing Activities		80,000	(1)
(D) Net Increase in Cash		10,000	
(E) Balance of Cash in the beginning		20,000	
(F) Balance of Cash at the end		30,000	(1)

Total = 6 marks

OR**Cash flow statement for the year ended March 31, 2003**

Particulars	Details	Amount
A Cash flow from operating Activities		
Net Profit before Tax	10,000	
Adjustments for non-cash & non operating items		
Add : Depreciation	1,000	½
Preliminary Expenses written off	40,000	½
loss on sale	5,000	½
Operating profit before working Capital changes	<u>56,000</u>	½

Add: Decrease in Current Assets & Increase in Current Liabilities Provision for doubtful debt	10,000		½
Less: Increase in Current Assets & Decrease in Current Liabilities, Debtors	(64,000)		½
Cash Flow from operating activities before Tax	2,000		
Less : Tax			
Cash Flows From operating activities after tax	-	2,000	
B. Cash Flow from Investing Activities			
Purchase of Plant	(42,000)		½
Sale of Plant	30,000		½
Sale of Investment	10,000		½
Cash flows from Investing Activities		(2,000)	
C. Cash Flow from financing Activities			
Cash generated during the year		-	
Add: Cash and Cash Equivalants at the beginning of the year		50,000	½
		50,000	½

Workings

(1) Net Profit Before Tax	
Balance of P&L A/c as on 31.03.03	54,000
Less: Balance of P&L A/c as on 31-3-02	50,000
	<u>4,000</u>
Add: Transfer to general Reserve	6,000
	<u>10,000</u>

(2) **Dr.** **Accumulated Depreciation A/c** **Cr.**

Plant A/c	25,000	Bal. B/d	56,000
Bal c/d	32,000	Depreciation	1,000
	57,000		57,000

(3) **Plant A/c**

Bal b/d	1,56,000	Accumulated Depreciation	25,000
Bank (purchase)	42,000	Bank	30,000
		Less on Sale	5,000
		Bal c/d	1,38,000
	1,98,000		1,98,000

(4) **Cash and Cash equivalents**

Particulars	Beginning	End
Cash	60,000	70,000
Less Bank Overdraft	10,000	20,000
	50,000	50,000

PART C

COMPUTERISED ACCOUNTING SYSTEM

16. Explain the concept of Data model with the help of an example.

Answer

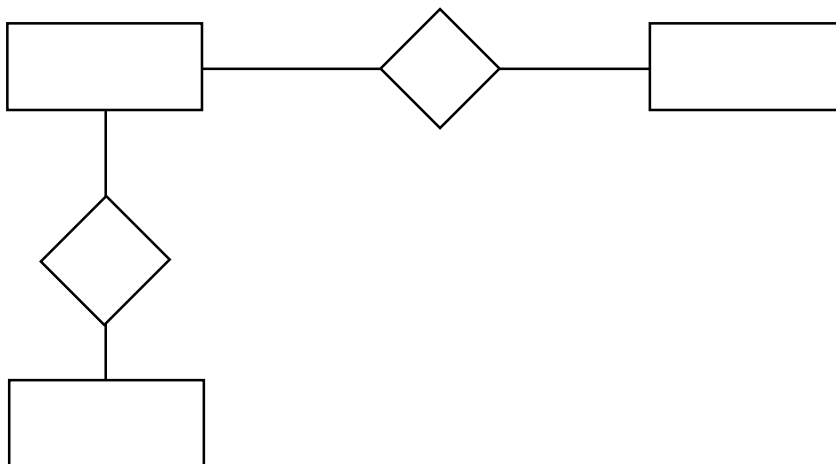

17. Explain with one example DML or DCL

Answer

DML

It means Data Manipulation Language. It is that set of commands of SQL which are used for manipulation of data. Manipulation of data means:

- * Inserting new records
- * Deleting existing records
- * Updating the existing records

DCL

It means Data Control Language. It means that set of commands of SQL which are used to control access to the information stored in the database. It may mean:

- * Granting privilege to different users about access to information
- * Revoking privilege to different users about access to information
- * Privilege may relate to retrieval, manipulation, control, definition of information

18. Write a series of queries to process the transaction data in such a manner as to result into information on Trial Balance.

Answer

Accounting Reality to be drawn which shows the tables containing data

Depending upon how the tables, are drawn, queries to be created to get the information about:

- * Name of the account
- * Whether debit or credit

- * Amount in the account
- * The total of the sides of debit or credit

19. Formulate the SQL statements for answering the following queries for an assumed design of an Accounting Reality:
- (a) List the transaction details of accounts which have been credited during the month of August, 2003
 - (b) List all the transacted accounts with the amounts by which they have been debited and also the amount with which they have been credited.
 - (c) List the amount of expenses authorised by each of the employees.

Answers

- (a) Select colname1, colname2
From tablename
Where condition fulfilling data requirement
 - (b) Select colname1, colname2
from tablename
where condition
 - (c) Select colname1, colname2
from tablename
Where condition
20. Formulate the SQL statements for answering the following queries for an assumed design of an Accounting Reality:
- (a) List item wise the quantity sold during the month of September, 2003.
 - (b) Find the Minimum and maximum rate at which each item of goods has been purchased during the period October, 2003.

- (c) Make a list of Invoice No., Date and Amount of Purchases during the period April 1,2003 to March 31, 2004, grouping them month-wise.

Answer

- (a) Select colname1, Colname2
From tablename
Where condition
- (b) Select colname1, Colname2
From tablename
Where condition
- (c) Select colname1, Colname2
From tablename
Where condition

21. Explain the concept of Relationship Degree. How is it different from Relationship Type? Give one example for each.

6

Answer

Relationship Degree

It refers to the number of relations associated with a relationship.

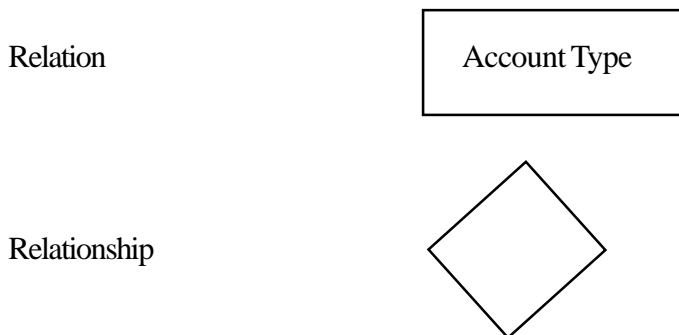

Give an illustration of a relationship of degree of two or three.

Relationship Type

It means the kind of relationship among instances (tuples) of relation (s)

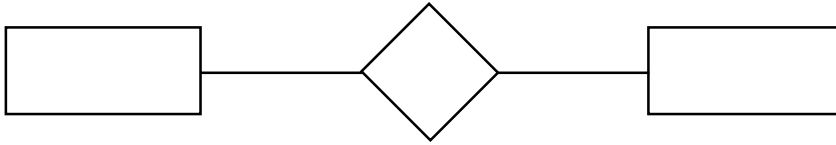

Give an example for Accounting reality.

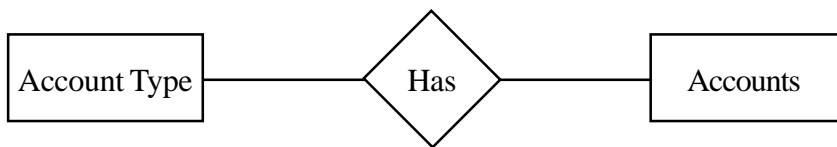

Relationship type could be:

1. one-to-one
2. one-to-many
3. many-to-many

SAMPLE QUESTION PAPER - SET II

QUESTION WISE ANALYSIS

S. No.	Instructional Objective	Specification	Content Unit	Form of Question LA/SA/VSA	Marks Allotted	Estimated Difficulty Level + (A,B,C)
1.	Understanding	Calculates	1	VSA	2	B
2.	Knowledge	Recalls	4	VSA	2	A
3.	Understanding	Shows presentation	4	VSA	2	B
4.	Understanding	Passes Journal Entry	5	VSA	2	B
5.	Knowledge	Recalls and lists	1	SA	3	A
6.	Knowledge	Recalls	5	SA	3	A
7.	Knowledge	Recalls	2	SA	3	A
8.	Understanding	Prepares Accounts	3	SA	4	B
9.	Understanding	Passes Journal Entries	4	SA	4	B
10.	Understanding	Prepares Account	5	SA	4	B
11.	Understanding	Passes Journal Entries	5	SA	4	B
12.	Application	Prepares account	2	LA	6	C
13.	Understanding	Prepares Accounts	3	LA	6	C
14.	Understanding	Passes Journal Entries	4	LA	6	B
15.	Understanding	Prepares Accounts	2	LA	8	C
16.	Knowledge	Recalls	6.2	VSA	2	A
17.	Application	Reasons	6.2	VSA	2	C
18.	Knowledge	Recalls	6.1	SA	3	A
19.	Understanding	Finds Ratios	6.1	SA	3	B
20.	Understanding	Calculates	6.1	SA	4	B
21.	Understanding	Calculates/works Out	6.2	LA	6	B

